

STRUCTURE WIDTH

30'

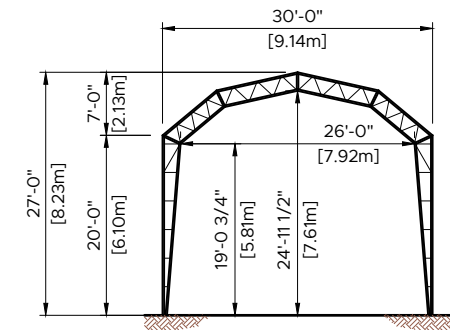

35'

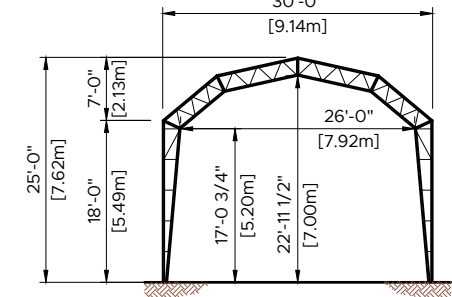
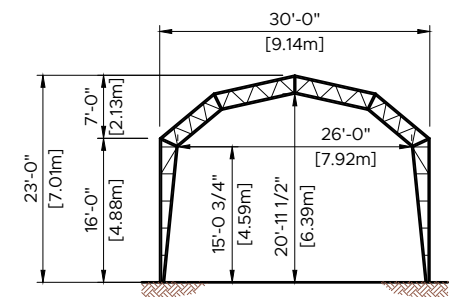
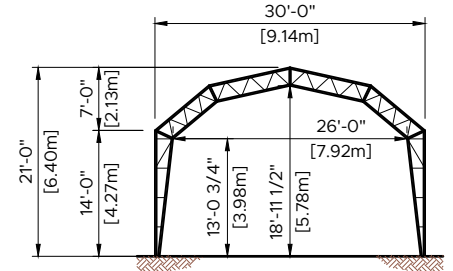
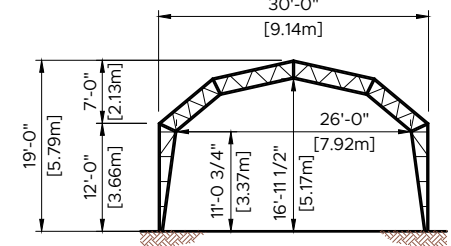
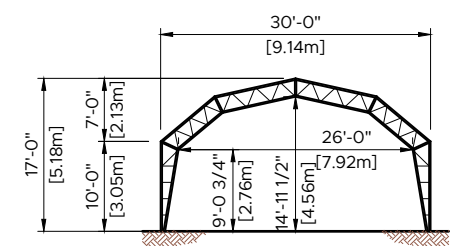
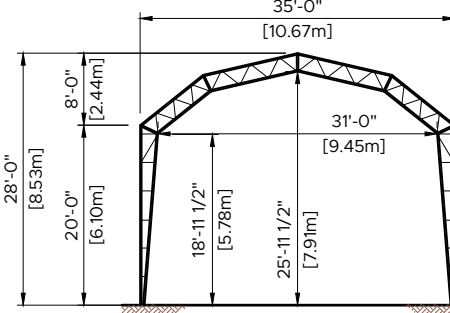
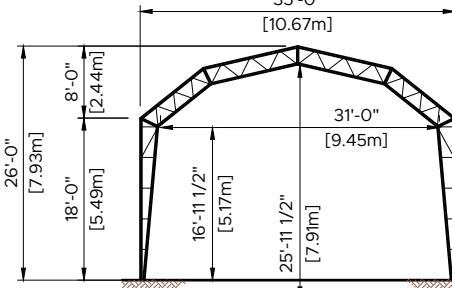
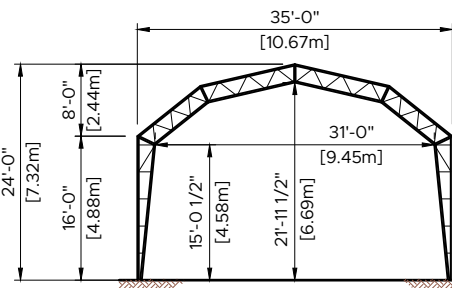
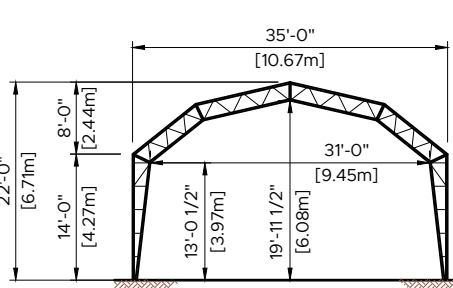
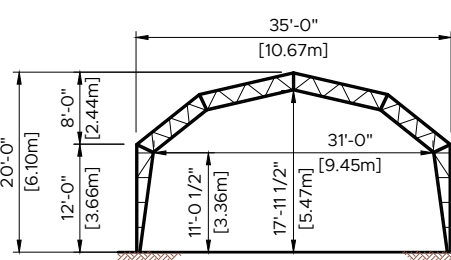
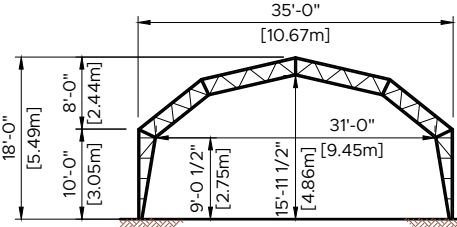

40'

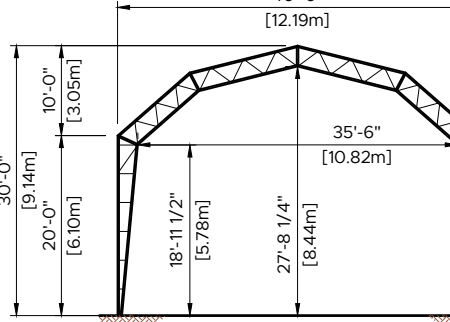
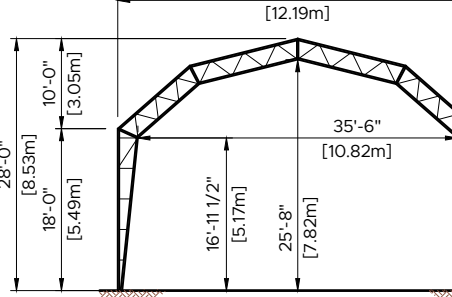
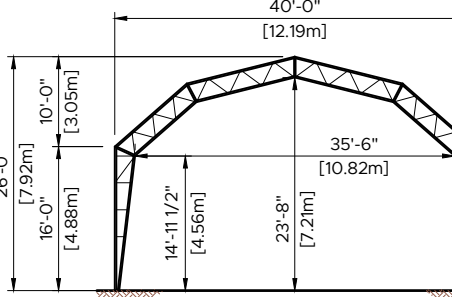
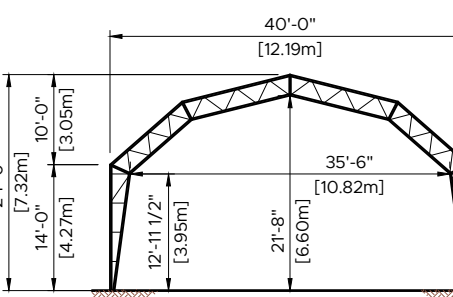
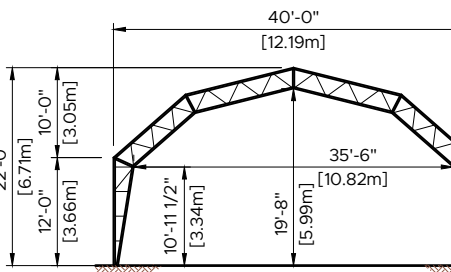
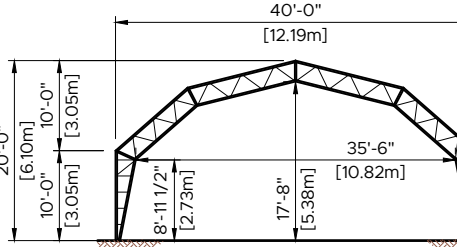

45'

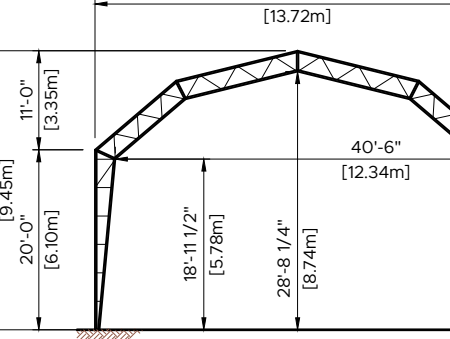
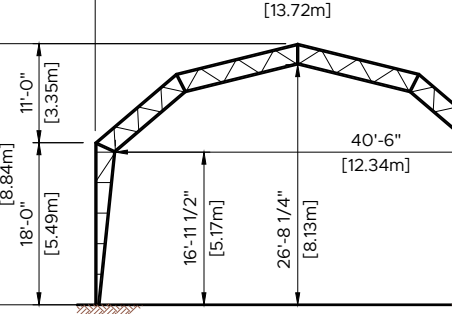
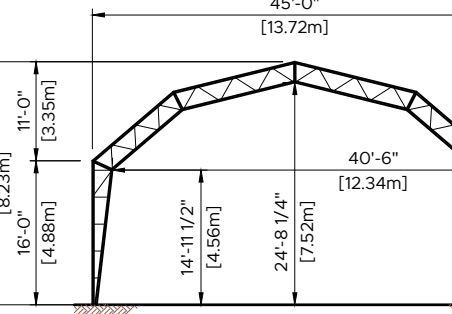
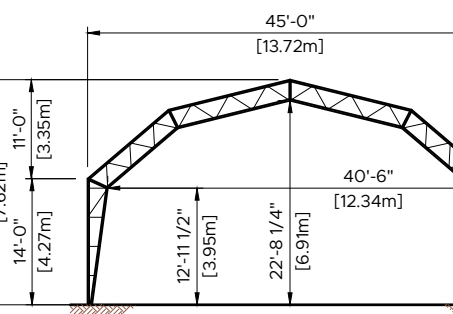
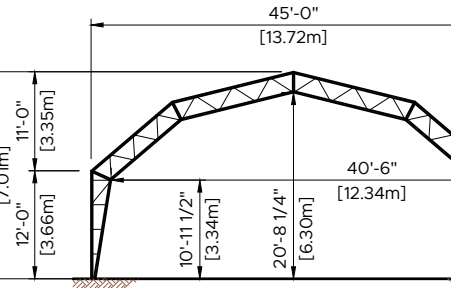
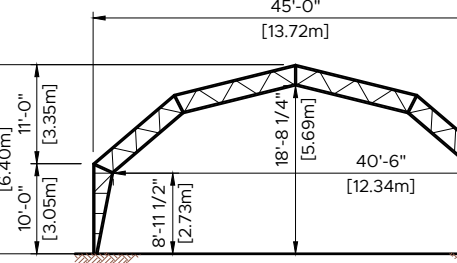

50'

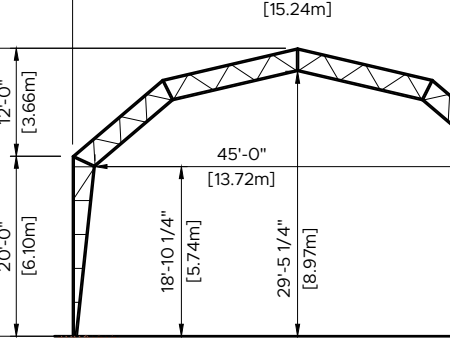
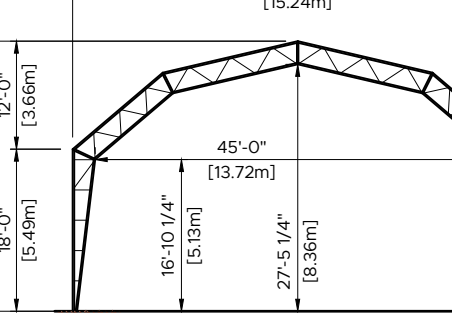
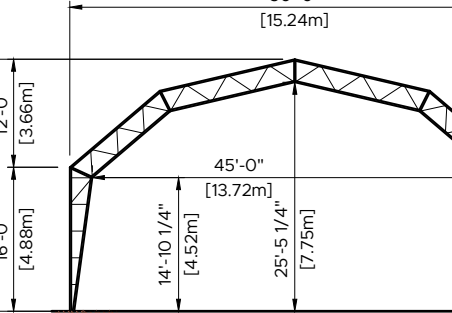
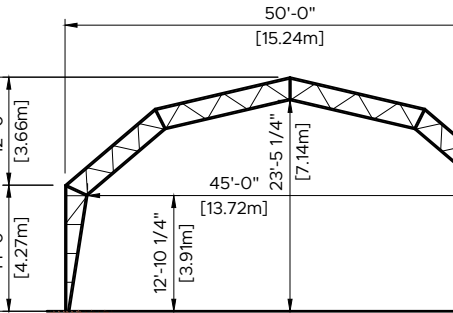
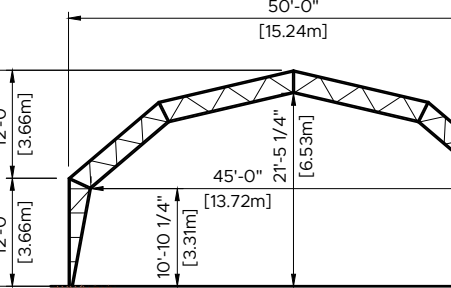
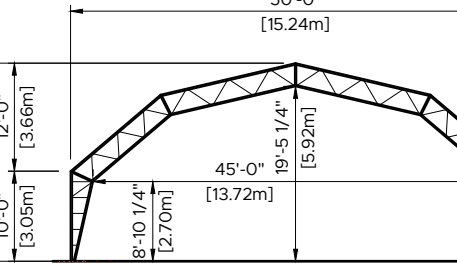

10'

12'

14'

16'

18'

20'

LEG HEIGHT

**HIGH PROFILE**

STANDARD FRAME SIZING AND CLEARANCES

PROFILE SCHEMATICS EXCEEDING DISPLAYED WIDTHS AVAILABLE BY PROJECT REQUEST

STRUCTURE WIDTH

55'

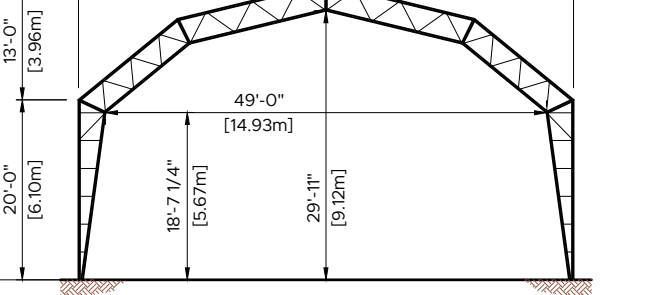
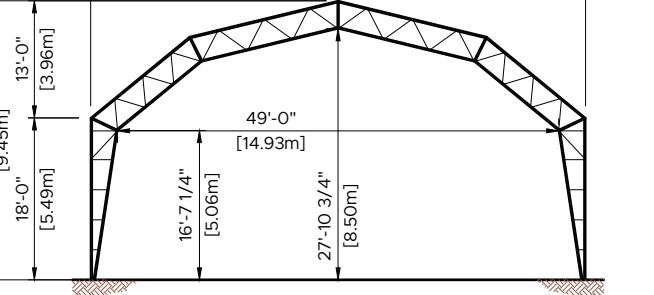
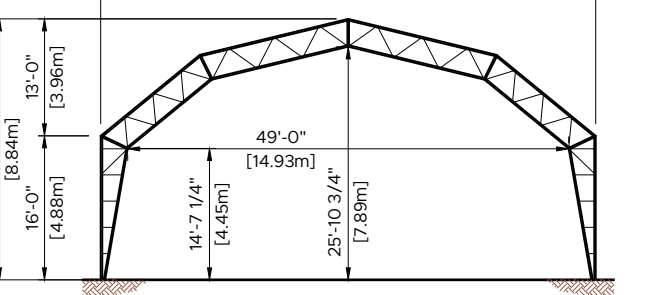
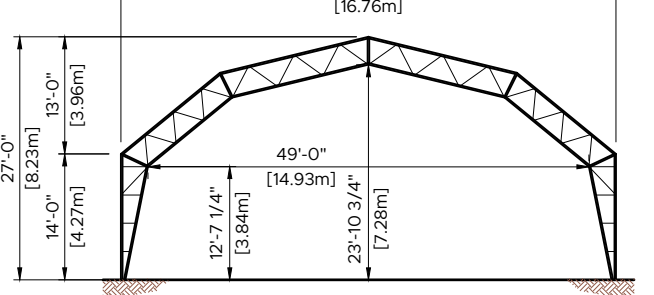
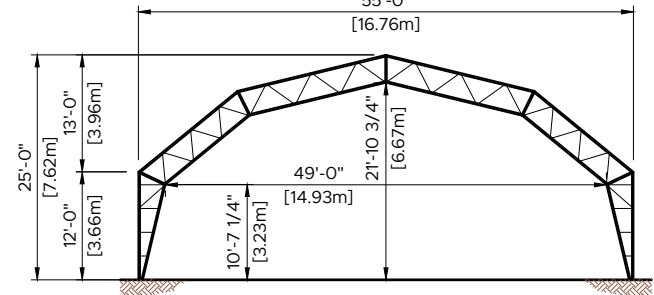
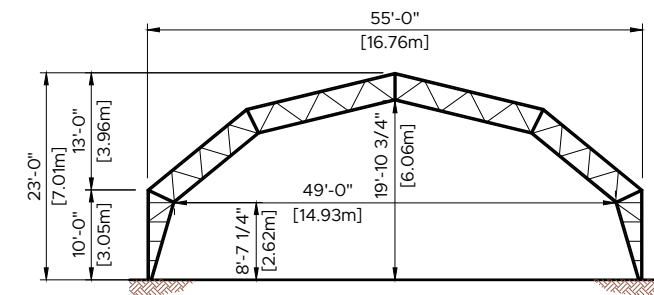

60'

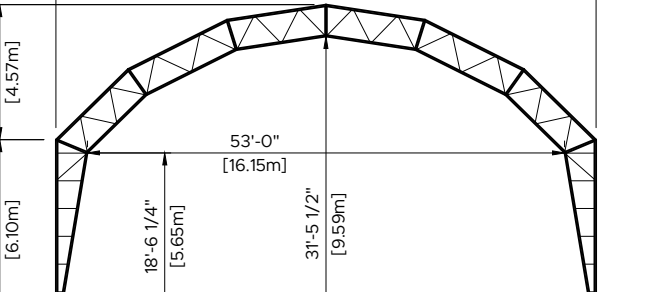
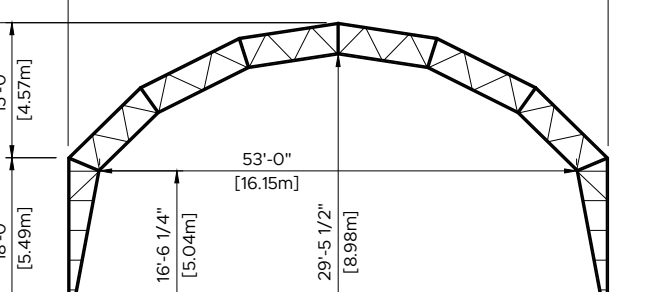
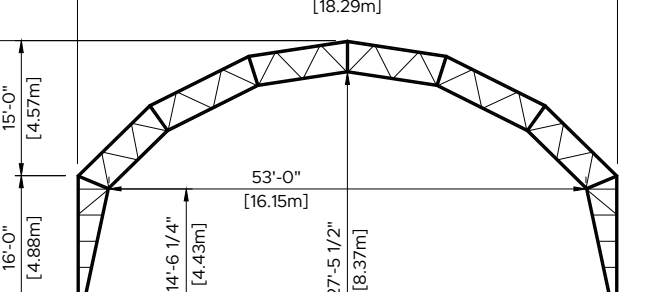
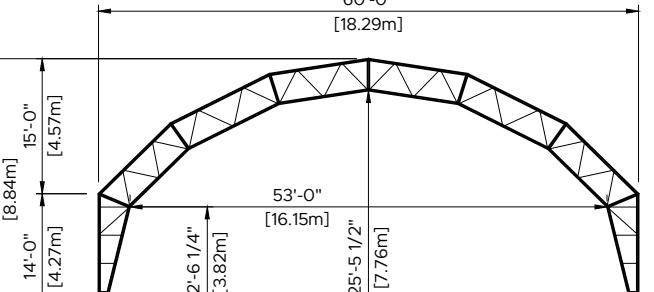
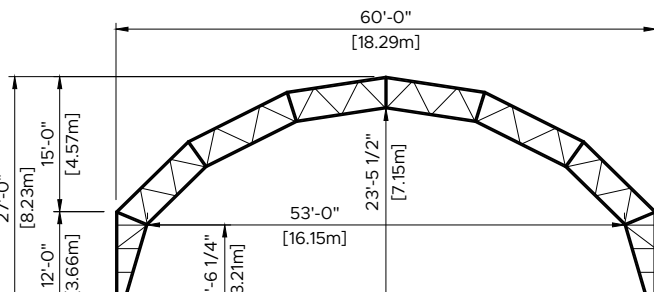
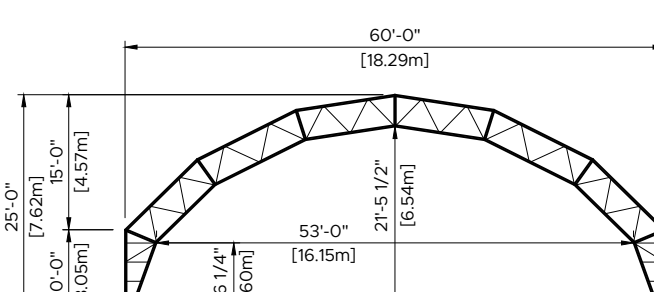

65'

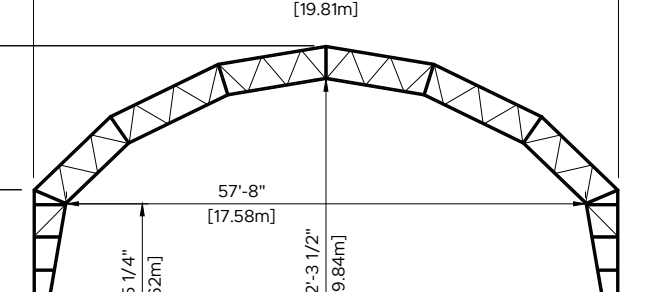
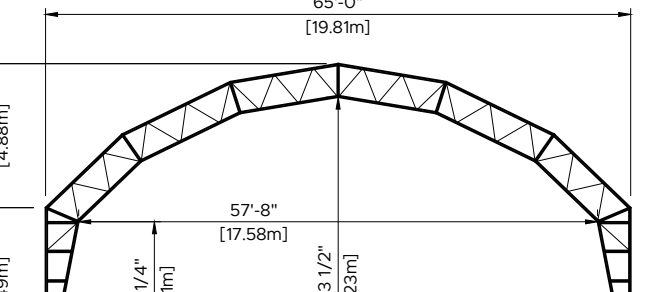
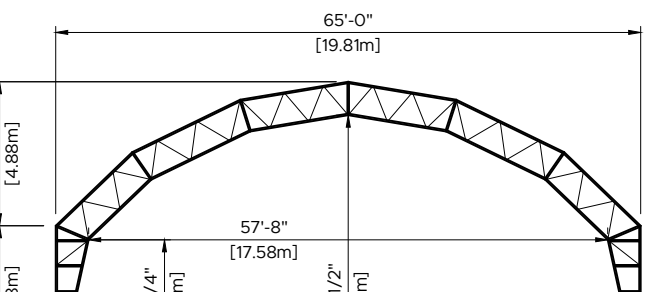
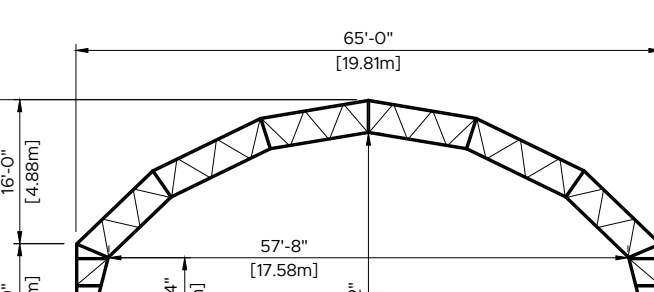
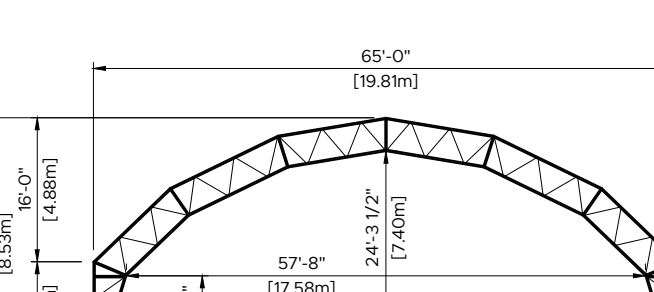
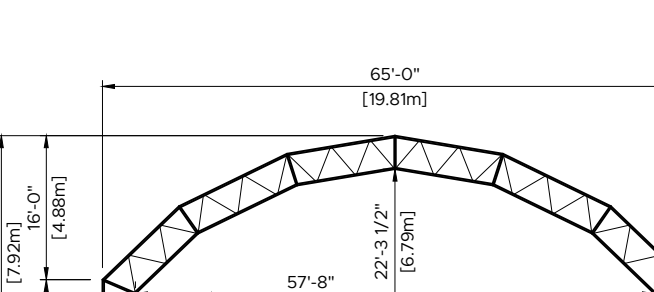

70'

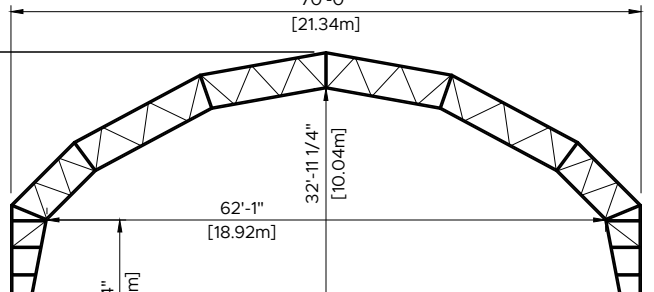
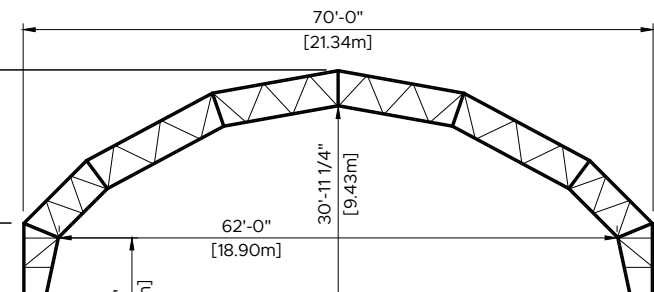
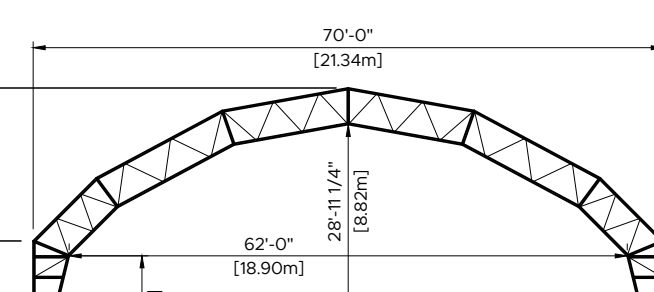
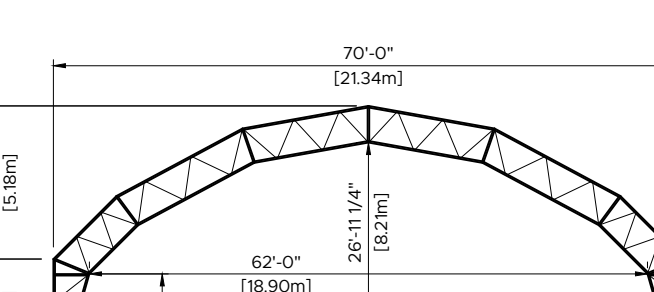
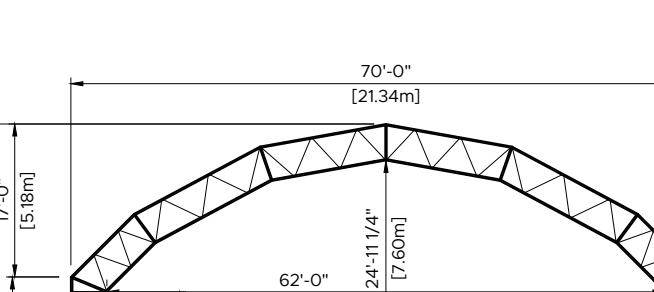
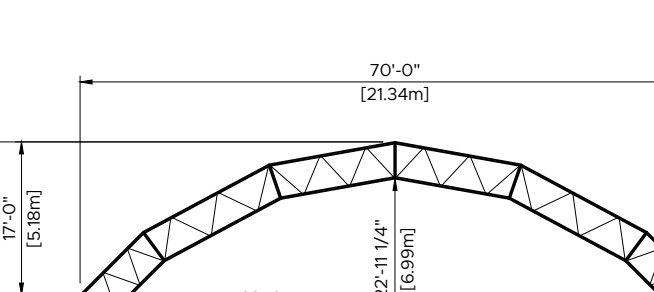

80'

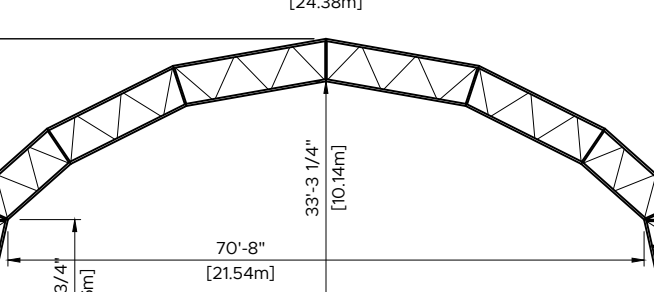
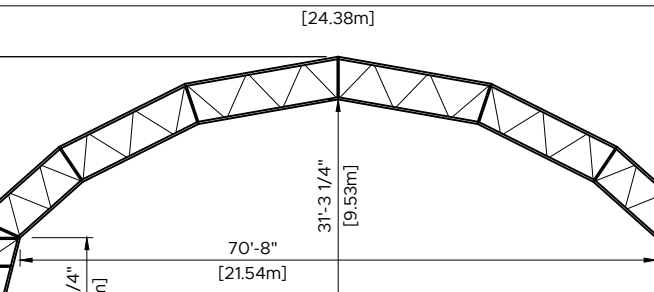
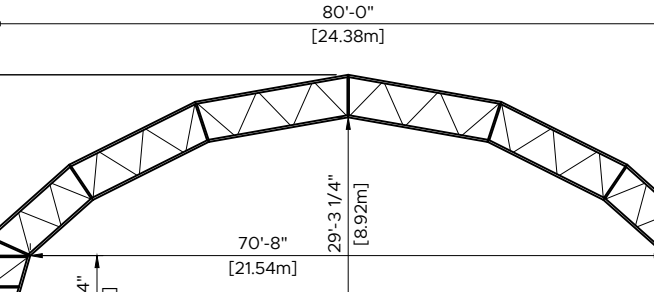
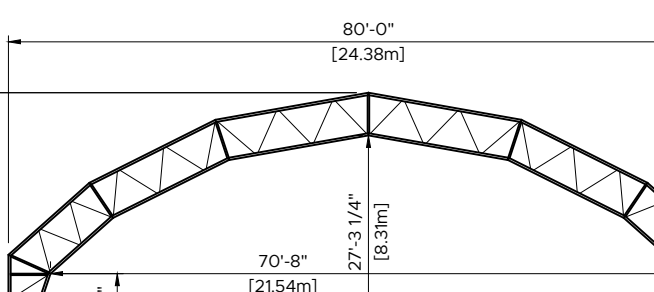
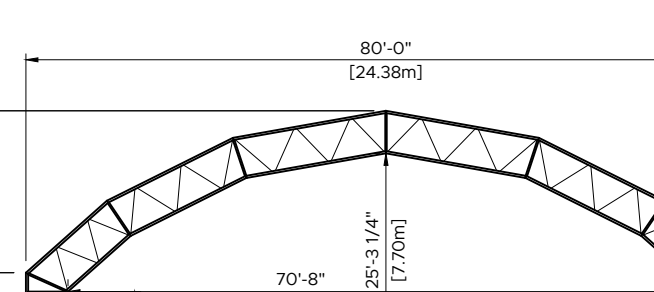
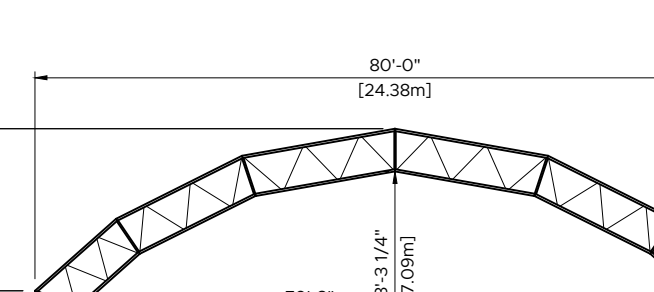

10'

12'

14'

16'

18'

20'

LEG HEIGHT

**HIGH PROFILE**

STANDARD FRAME SIZING AND CLEARANCES

PROFILE SCHEMATICS EXCEEDING DISPLAYED WIDTHS AVAILABLE BY PROJECT REQUEST