

STRUCTURE WIDTH

30'

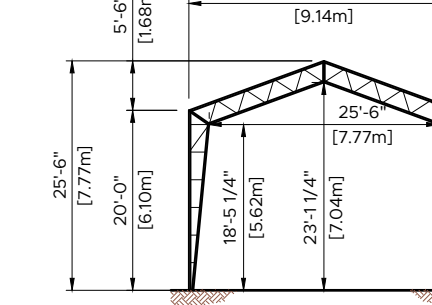

35'

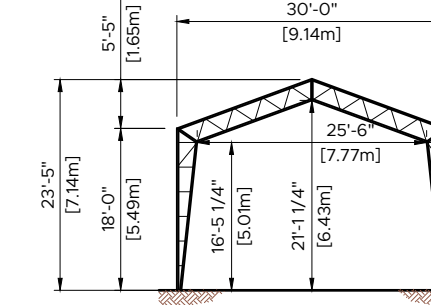
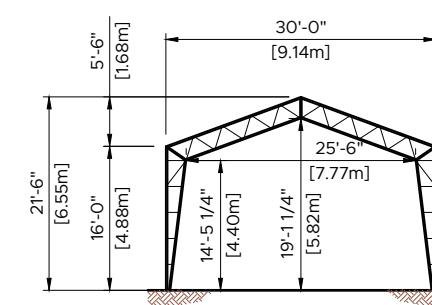
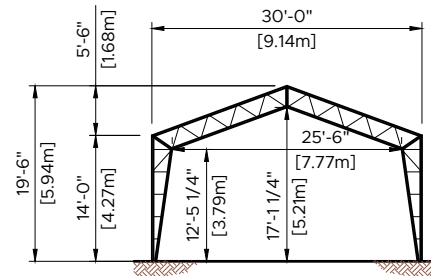
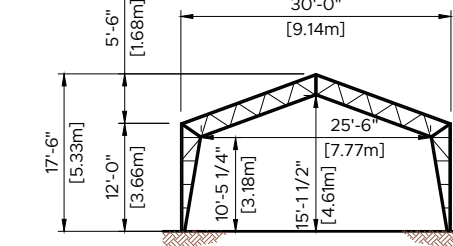
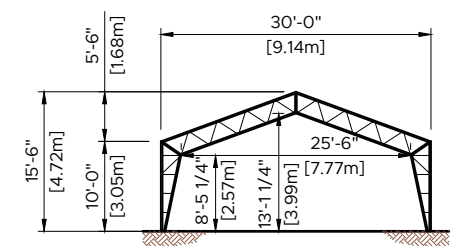
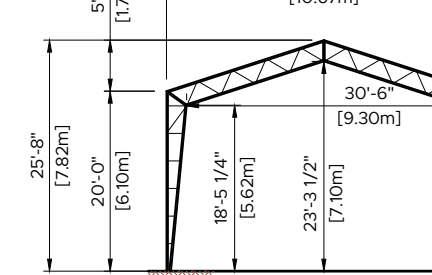
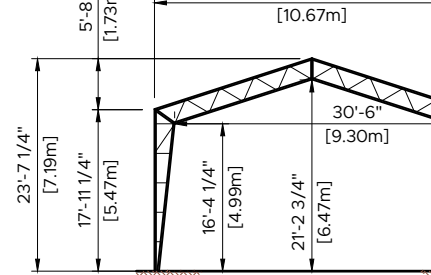
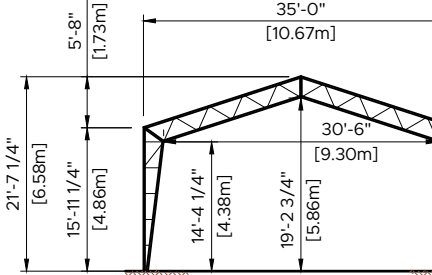
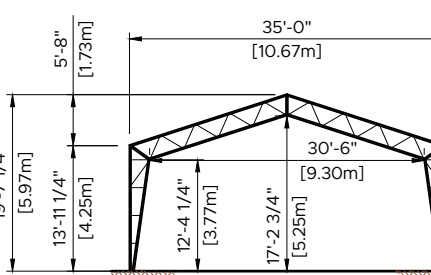
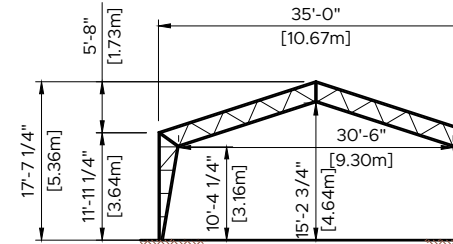
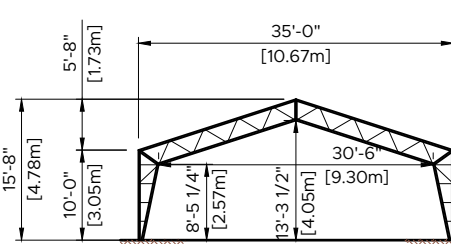

40'

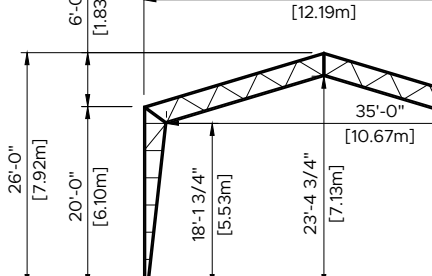
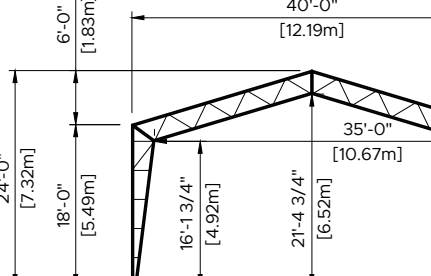
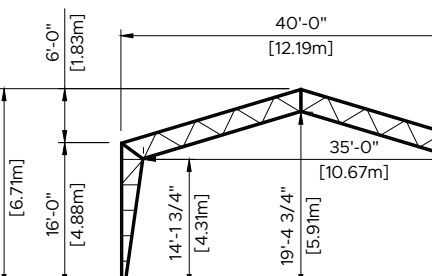
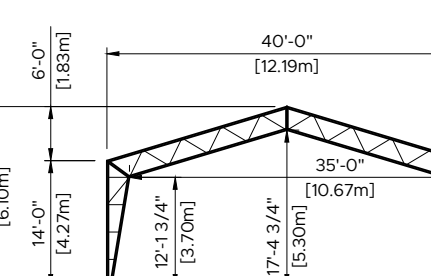
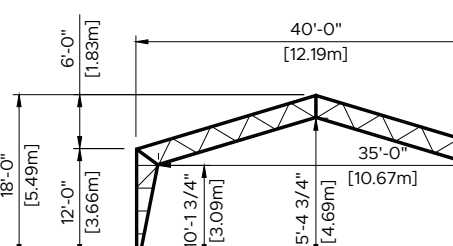
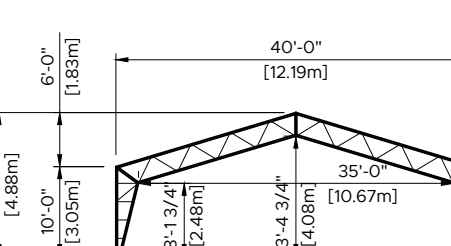

45'

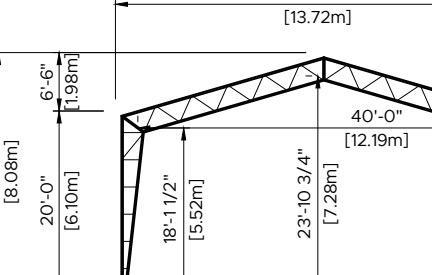
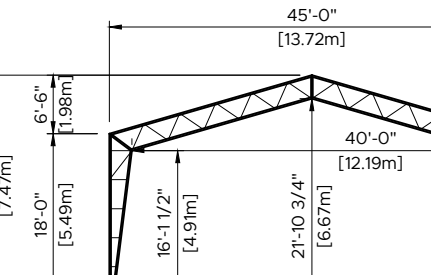
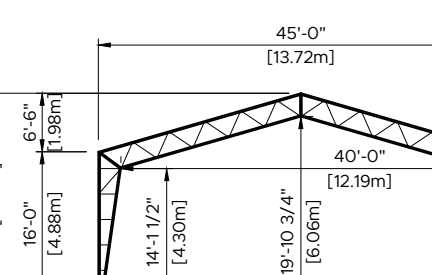
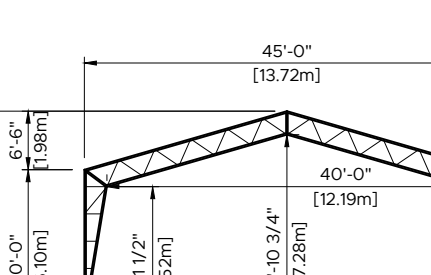
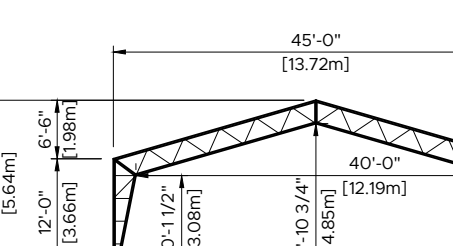
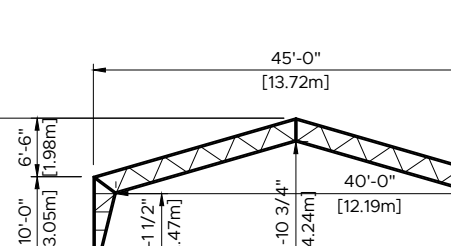

50'

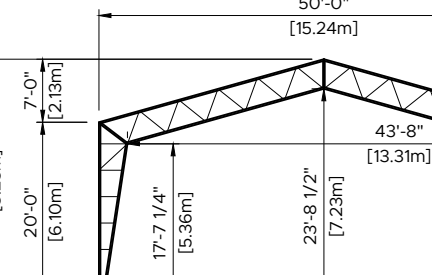
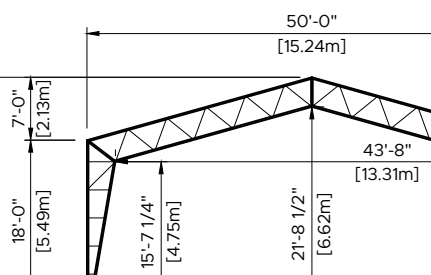
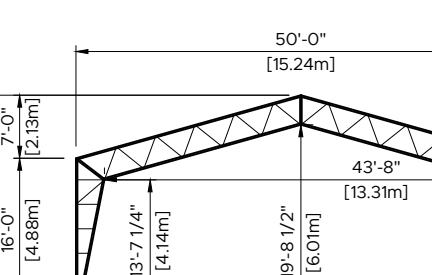
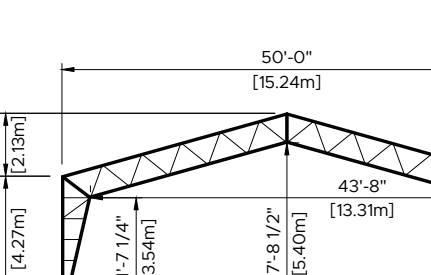
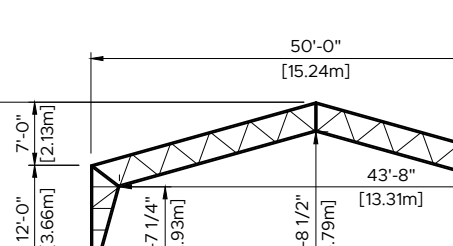
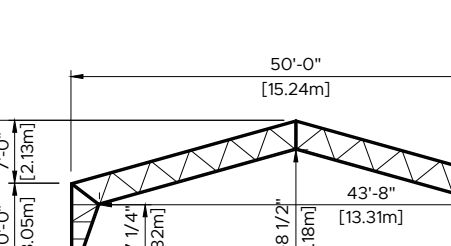

10'

12'

14'

16'

18'

20'

LEG HEIGHT

LOW PROFILE

STANDARD FRAME SIZING AND CLEARANCES

PROFILE SCHEMATICS EXCEEDING DISPLAYED WIDTHS AVAILABLE BY PROJECT REQUEST

STRUCTURE WIDTH

LOW PRO

55'

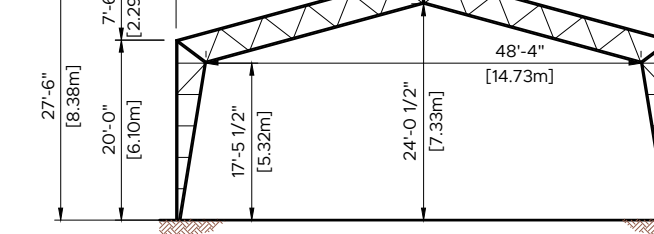
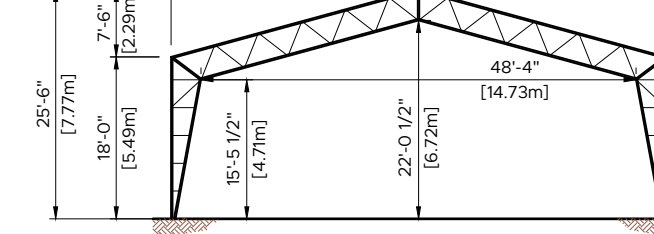
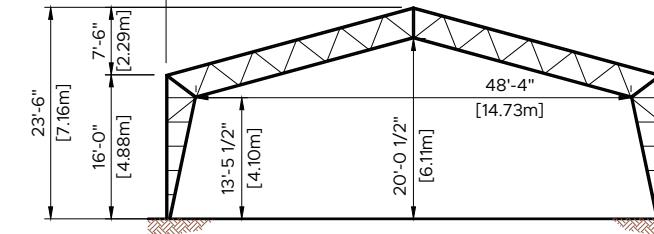
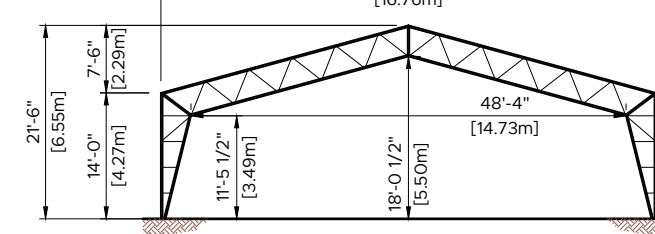
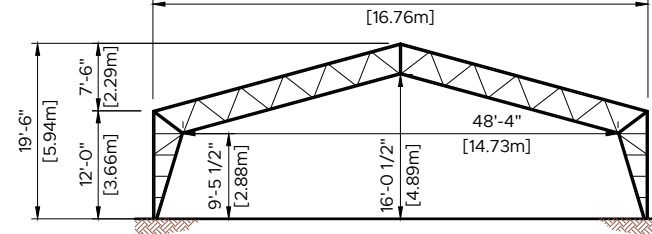
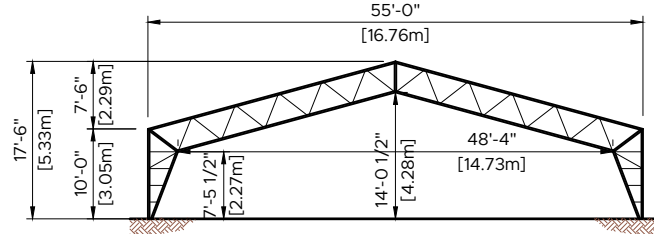

60'

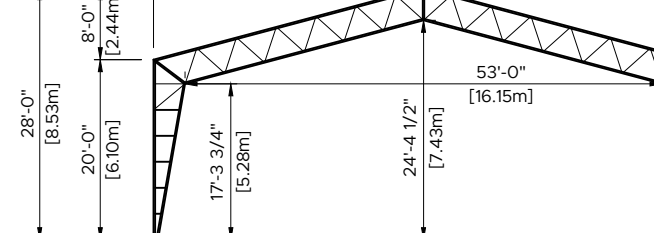
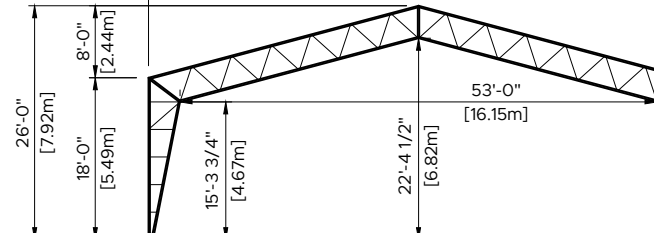
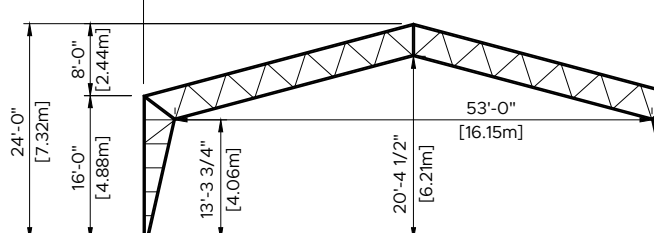
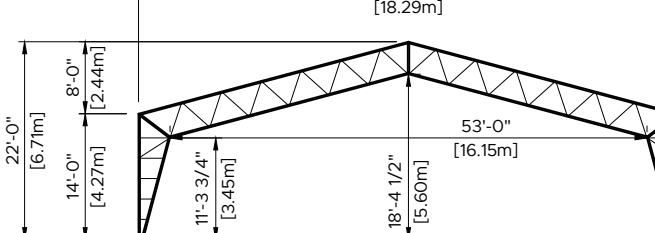
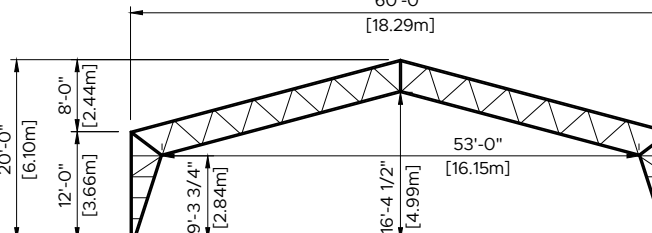
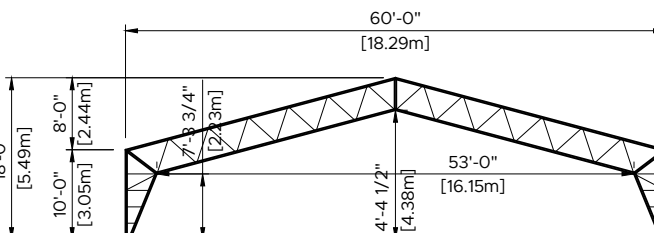

65'

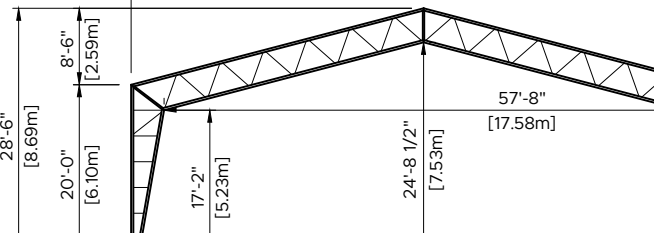
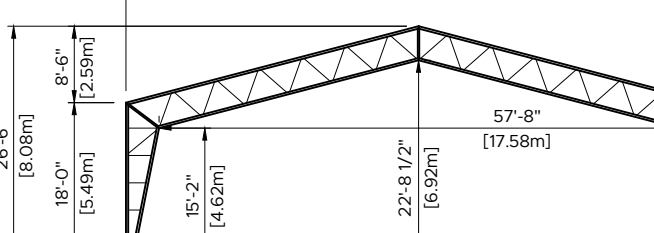
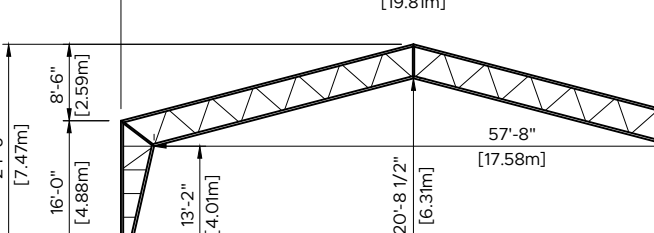
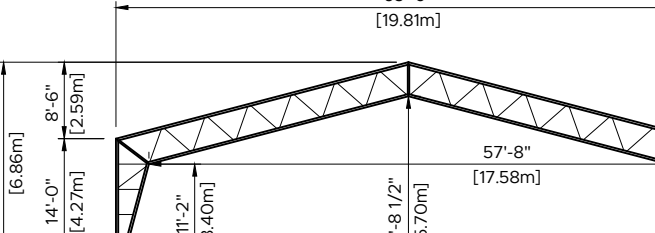
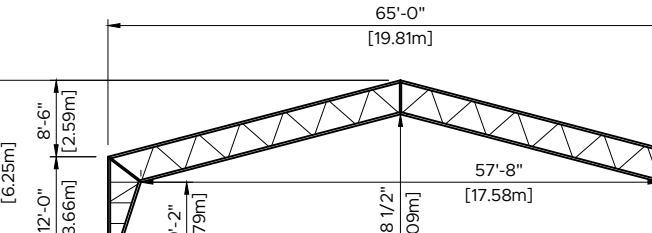
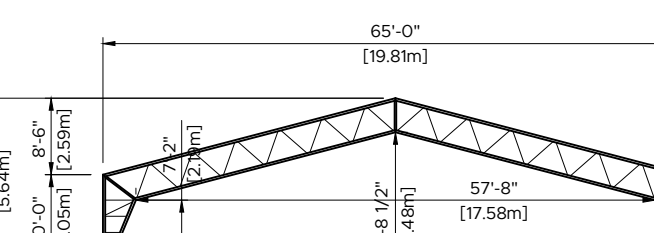

70'

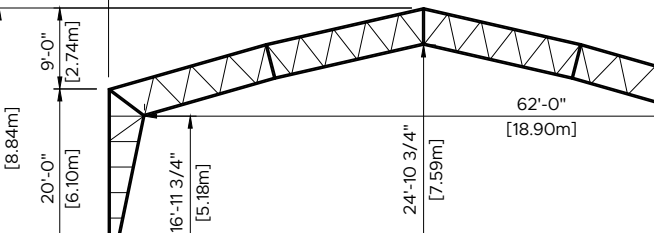
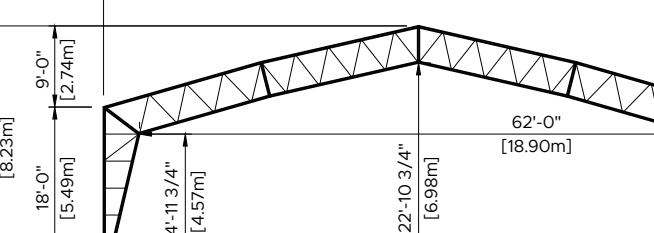
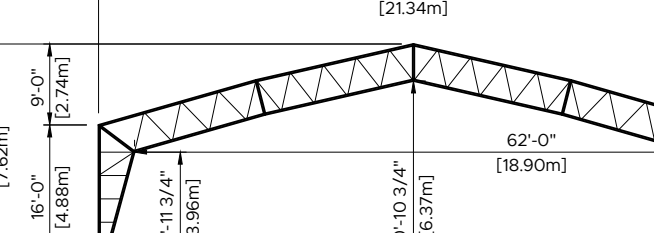
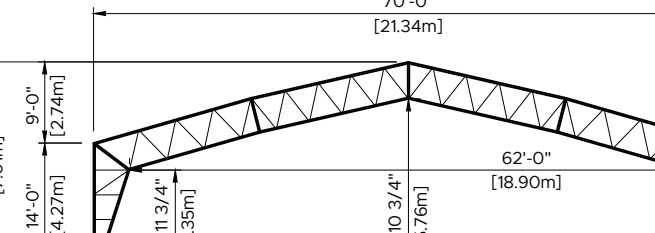
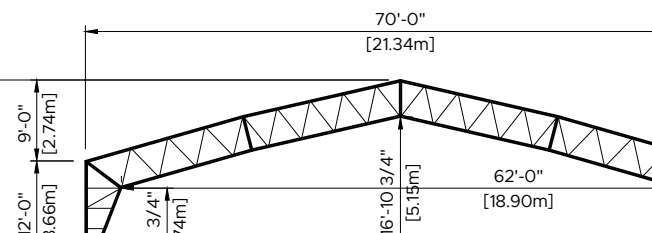
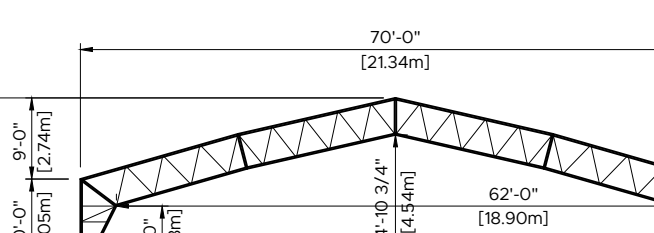

80'

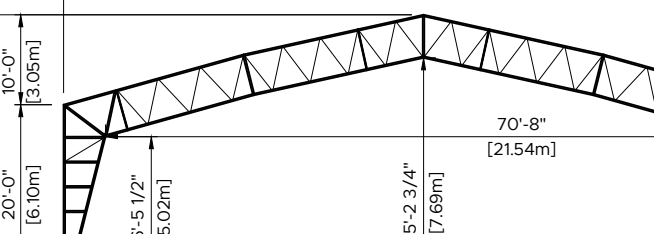
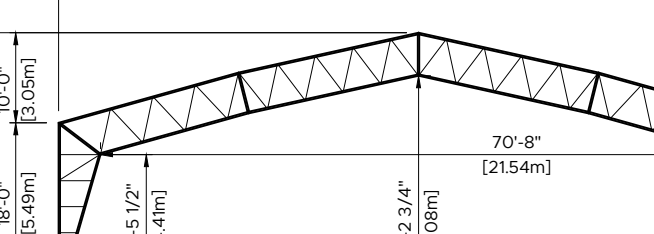
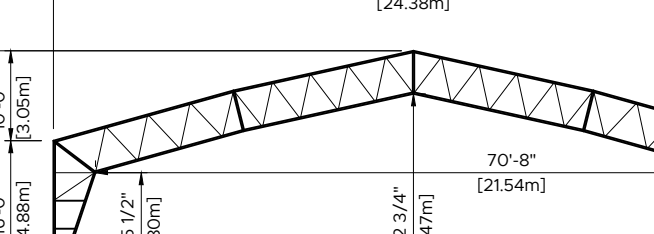
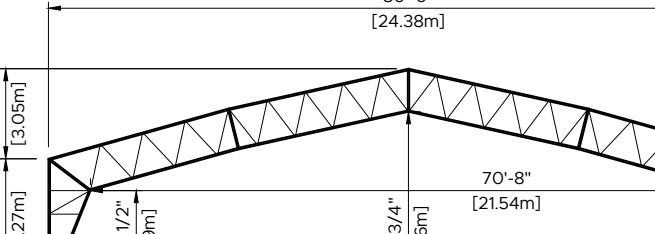
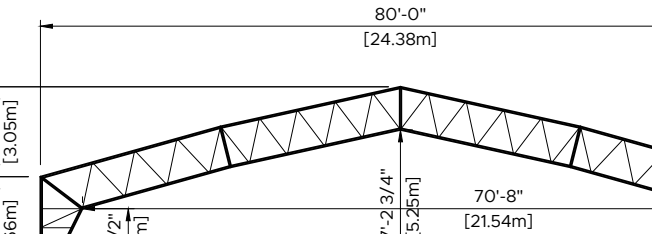
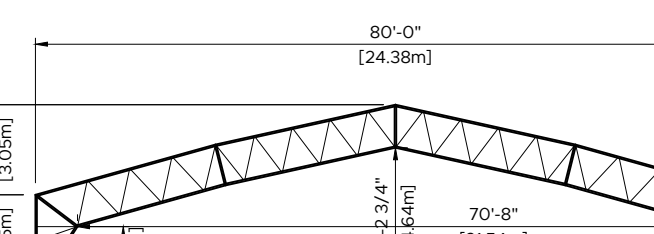

10'

12'

14'

16'

18'

20'

LEG HEIGHT

LOW PROFILE

STANDARD FRAME SIZING AND CLEARANCES

PROFILE SCHEMATICS EXCEEDING DISPLAYED WIDTHS AVAILABLE BY PROJECT REQUEST